



THE i4



#bornelectric

ELECTRIFYINGLY EMOTIONAL.

Attraction is something that cannot be explained. Sometimes, all it takes is the slightest touch. A single look. Something grabs us, flows through us, will not let us go.

Attraction becomes fascination. Fascination becomes enthusiasm. Enthusiasm becomes utter euphoria.

Attraction is something that cannot be explained. But it is something that can be experienced:
in the new BMW i4.



HIGHLIGHTS
JOURNEY

MODELS

EQUIPMENT

TECHNICAL VALUES



Highlights

- Exterior and interior design
- Charging
- Connectivity and infotainment
- Assistance systems
- i meets M

Models

- Base
- M Sport package
- i4 M50

Equipment

- Exterior colour world
- Interior colour world
- Wheels and tyres

Technical values

BMW i4 eDrive40:

19" aerodynamic wheels 855 bicolour with mixed tyres, exterior colour in Mineral White metallic, sport seats in 'Vernasca' leather Oyster decorative stitching | Black, interior trim finisher in fine-wood trim Oak grain open-pored with Pearl Chrome accent strip.

BMW i4 M50:

19" M light-alloy wheels double spoke 861 M bicolour with mixed tyres, exterior colour in BMW Individual Frozen Portimao Blue metallic, M sport seats in 'Vernasca' leather Black/contrast stitching Blue | Black, M interior trim finishers 'Carbon Fibre' with highlight trim finisher Pearl Chrome.

Alterations in standard and optional equipment and the configurations available for the different models, as described in this brochure, may occur after 06/02/2021, the date when this brochure went to press. Your local BMW Partner is available to provide further details. Subject to change in design and equipment.

Stated prices apply for models available in Germany. All prices shown are BMW AG's recommended prices ex works excluding delivery charges.

EMOTION – ELECTRICALLY INTERPRETED.

The new BMW i4 wears its innovative character on its sleeve like the sporty extrovert it is. Its futuristic exterior design combines athletic aesthetics with a clear surface language and progressive precision.

The unique focal elements in the interior create a luxurious atmosphere that turns every drive into an unforgettable experience.



A LOOK TO SET YOUR PULSE RACING: THE FRONT END.

The front of the new BMW i4 is characterised by expansive closed surfaces in the vehicle colour and precise lines. A black inlay in the front apron and vertical side openings emphasise the functional, modern character of the vehicle from this perspective. The absolute highlight, however, has to be the concise, almost closed reinterpretation of the radiator grille, with its exclusive, high-quality design: this is what it looks like to always be a step ahead of progress.



■ A sign of intelligence and aerodynamics: **the kidney grille with its blue border** and the blue ring around the **BMW emblem** allow you to recognise the innovative technology that goes into the BMW i4 – even from the outside.

□ Flat, strikingly contoured **headlights** help the BMW i4 focus forward. Blue accents in its richly detailed, slender form add an emotional flair – in this case, indicating the integrated **BMW Laserlight system**.

THRILLINGLY PROGRESSIVE: THE SIDE VIEW.

The dynamic gestures that highlight the side view are characterised by a long wheelbase, the fluid lines of the roof and short overhangs. Expansive, gently modelled surfaces with precise character lines create a modern technical overall impression that also exudes all the elegance of a true BMW Gran Coupé. No question: this model is dominated by an awareness of always being at the forefront – effortlessly.

■ The blue accents on the functional **air breather** and door sill not only intensify the modern, more aerodynamic look of the new BMW i4, but also speak of the battery technology that lies deep within its floor.



A HEAD-TURNER AT FIRST GLANCE: THE REAR.

The rear view impressively showcases how an uncompromisingly clear surface language can be the ideal, unmistakable finishing touch for the overall appearance of a vehicle. Sharp vertical rear spoiler set the new BMW i4 apart from the road. In between, recessed surfaces add striking athletic flourishes and strengthen the sporty, wide effect from this angle.

■ The **rear lights with LED technology**, with their slender contours and horizontal lines, highlight how closely the new BMW i4 hugs the road. The characteristic interpretation of the concise L-shape thanks to the large LED light element makes the rear even more recognisable.

■ The new BMW i4 is wide and confident. This self-confident impression is further amplified by its **bicolour rear apron** the lower section of which is black in colour, matching the door sill. Together with the slender, horizontal rear lights and the **chunky tailgate**, this creates an extensive horizontal impression that immediately draws the eye.



■ The **BMW Curved Display**, with its curved connection between the **12.3" instrument cluster** and **14.9" Central Information Display**, adds a high-quality, modern touch to the cockpit of the vehicle. Curved to face the driver, it represents a new, particularly intuitive form of typical BMW driver orientation. Virtually all functions are integrated into the system – even the air conditioning controls can be accessed via the touchscreen. This means that physical switches only appear inside the new BMW i4 where they are really practical.



ROOM FOR EMOTIONS: THE INTERIOR.

Open, luxurious and fascinatingly aligned with the needs of the driver as well as those of all the passengers: the interior of the new BMW i4 unveils the next generation of advanced driving. The interplay of high-quality materials, a multimodal, intuitive operating concept and a sporty feel

in the seat, with separated areas for the driver and front passenger, creates an atmosphere that is every bit as delightful on long journeys as it is during shorter drives.





□ The best seats in the front row: the comfortable embrace of the sport seats in Oyster 'Vernasca' leather is given an especially elegant boost by their **high-quality decorative stitching**.

High-tech meets feel-good atmosphere: cutting-edge technology from its emotional side in the new BMW i4.

■ Total comfort, even in the back seats: up to three passengers can enjoy an **exclusive travel experience with generous head and leg room** amid an inviting, brightly-lit atmosphere in the new BMW i4.

■ The **tailgate** of the new BMW i4 makes loading and unloading the roomy, 470-litre luggage compartment child's play, while the functional rear seat bench can be folded down for increased flexibility, allowing you to maximise storage.



Flexible charging with up to **11** kW of output



AT HOME EVERYWHERE – FLEXIBLE AND MOBILE CHARGING WITH THE FLEXIBLE FAST CHARGER.

■ The standard Flexible Fast Charger offers maximum flexibility when charging at home. The quick charger always adapts to the charging infrastructure thanks to the available cable adapters and can be connected to both household and industrial sockets. You can take the compact, light Flexible Fast Charger with you wherever you go and also charge your BMW in another "home" location, for example a second or holiday home.

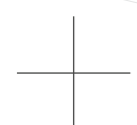

RAPID CHARGING. DRIVE FURTHER. EXPERIENCE MORE.

BMW Charging is our all-round carefree solution for charging your BMW. With BMW Charging products and services, you have a wide range of tailor-made offers for charging available at home and on the road. The charging cable for public charging (mode 3) and the BMW Charging Card are already included in the standard equipment. This gives you access to a network of over 450,000 charging points worldwide in city centres, car parks and along major traffic routes – including high power charging stations for

ultra-fast charging. Most vehicles also come with the Flexible Fast Charger for flexible charging at home. You can add further BMW Charging options based on your preferences and needs, e.g. Wallboxes for particularly convenient charging at home. Whether hardware for charging, digital services or servicing, our offerings are constantly growing. This also includes an installation service for your wallbox or a special green electricity tariff for charging at home.



EASY CHARGING NO MATTER WHERE YOU ARE, WITH THE BMW CHARGING CARD AND CHARGING CABLE FOR PUBLIC CHARGING.

■ Long journeys are a particular pleasure with the new BMW i4 – after all, you already have everything you need to charge along the way: The **BMW Charging Card** enables you to seamlessly access an extensive international charging network – including ultra-quick charging stations for ultra-fast charging. Enjoy especially attractive public charging fees that are optimised for your specific market, established and activated exclusively for BMW drivers – and with no basic charge to pay in the first year for new vehicle drivers. With the **five-metre long standard charging cable (mode 3) for public charging** using alternating current (AC), all you need to do to get charging is connect your new BMW i4 easily and safely to an AC charging point from the BMW Charging Network while you are on the road.



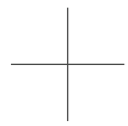

CONVENIENCE KNOWS NO BOUNDARIES.

Enhance your charging equipment with customised BMW Charging solutions. For instance with a Wallbox to charge your vehicle from home even more conveniently. Our installation service will be happy to connect it and set it up at your home for you. Or a green electricity tariff, providing renewable energy,

also for charging at home: maximum low-emissions charging and driving with your new BMW i4. The options are almost endless – with BMW Charging you can experience the fully fledged variety of modern mobility.

BMW WALLBOX FOR FAST AND CONVENIENT CHARGING AT HOME.

□ The BMW Wallbox¹ offers you safe, stress-free and convenient charging. With the permanently installed robust and outdoor-ready BMW Wallbox, you

can charge your new BMW i4 quickly and reliably with currently up to 11 kW (3-phase). In addition to its compact dimensions in a characteristic BMW design, the BMW Wallbox also offers convenient cable management including

connector and wall mount. Thanks to the integrated current leakage detection and a service app, installation is simple and cost-effective – and you can book this service for the BMW Wallbox right away.



ULTRA-FAST CHARGING HAS A NAME: IONITY.

On the road, you have access to BMW Charging's ever-growing public charging network, which includes a wide range of High Power Charging (HPC) stations, e.g. from our partner IONITY along the main traffic routes throughout Europe. These charging points can be displayed by the navigation system in the vehicle or by an app - all you need to do is set the appropriate filter. This enables ultra-fast charging with direct current (DC) at an HPC charging point: The battery of a new BMW i4, for example, is charged from 10 to 80 percent in less than 40 minutes with up to 210 kW charging power.

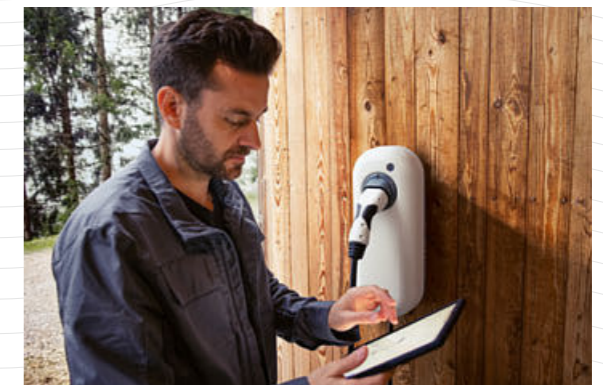

SMART WALLBOX.

□ Even smarter charging at home: In addition to a charging power up to 22 kW the Smart Wallbox¹ offers our partners comprehensive connectivity. This makes smart, additional services for intelligent charging possible. For instance, the Smart Wallbox can be integrated into an existing home energy management system and conveniently controlled online. Accurate registering and billing of charging processes is also possible.

■ Standard equipment □ Optional equipment

¹ Equipment available as an option from Original BMW i Accessories.

The availability of some equipment, functions, and digital services depends on engine variants or additional optional equipment. The offer structure as well as market and

production availability may vary. For detailed information on availability, terms and costs, please contact your local BMW partner.

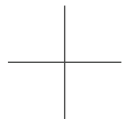

PROGRESS THAT CONNECTS.

Leave everything behind – but stay connected with what is important to you: The extensive connectivity and infotainment functions in the new BMW i4 ensure that you are at the centre of the action on every trip – no matter where the road takes you.



Use real-time navigation, make and receive calls, send and receive messages, listen to music, use voice control with Siri and more: thanks to **smartphone integration** with Apple CarPlay, you can conveniently access various functions of your iPhone directly in your vehicle, display them in large format on the Head-Up display¹ in your new BMW i4 and control them easily without manual input using voice control directly via Siri.



■ With **BMW iDrive**, you can enjoy an even more convenient and innovative range of options for controlling your new BMW i4. In conjunction with the large **BMW Curved Display** it ensures that you can view all information promptly and clearly. This is also supported by the **BMW Operating System 8³**, which can be used intuitively via touchscreen, iDrive Controller and voice control thanks to its progressive, modern user interface.

□ Concierge Service, Remote Services, BMW Maps, smartphone integration² incl. Apple CarPlay and Android Auto or even In-Car Experiences? Why order individual options when you can have everything? With the **Connected Package Professional**, you can get these services from BMW ConnectedDrive.

■ Standard equipment □ Optional equipment

¹ The information in the BMW Head-Up Display is not fully visible when viewed through polarised sunglasses. Content shown will depend on the equipment options chosen. Further optional equipment is required to display specific items.

² Smartphone Integration is permanently available in the vehicle. It includes Apple CarPlay and Android Auto. Due to possible future technical developments (e.g. of mobile phones), the usability of the Apple CarPlay or Google Android Auto service

cannot be guaranteed permanently. CarPlay is a trademark of Apple Inc. Android Auto is a trademark of Google LLC.

³ Functions that process personal data are only available in conjunction with a BMW ID. In the guest profile, these functions cannot be used for the protection of personal data. Further information on data processing can be found in the ConnectedDrive Data Protection Information/Service Descriptions.

The availability of some equipment, functions, and digital services depends on engine variants or additional optional equipment. The offer structure as well as market and production availability may vary. For detailed information on availability, terms and costs, please contact your local BMW partner.

TECHNOLOGY OPTIMISED TO SUIT YOUR NEEDS.

The new BMW i4 is always at your side, providing reliable support even in challenging driving situations. A smart combination of sensors, assistance systems and safety technologies ensures that you feel perfectly at ease on every journey and can skilfully master any situation.

□ Making bothersome routines a pleasure: its numerous cameras will improve your overview and make it easier to manoeuvre and park your new BMW i4. If you like, the **Parking Assistant Plus²** can even park your car for you and drive it out of your parking space – everything about the new BMW i4 is geared towards making every drive a unique experience from start to finish.



□ **Driving Assistant Professional¹** supports you like a smart co-pilot. It prepares your vehicle perfectly for each lane change, takes over the steering in slow-moving traffic, automatically creates an emergency lane when necessary, and much more. That means that you can concentrate fully on the thing that is the most pleasing about the new BMW i4: that unique electric driving feel.

■ Standard equipment □ Optional equipment

¹ Function may be limited in darkness, fog or bright glare.

² The driver is responsible for constantly monitoring the automated parking procedure in accordance with local road laws.

PURE ADRENALINE MEETS ELECTRIFYING FORWARD THRUST.

A new era: in launching the new BMW i4 M50, BMW M is transferring the athletic design, powerful drivetrain systems and precise driving characteristics of BMW M to an innovative BMW i for the very first time.



■ The sporty, exclusive interior of the new BMW i4 M50 intensifies that feeling of ultimate driving pleasure: sitting in its **sport seats with their distinctive M upholstery** makes it feel even more exciting to be driving out in front of all the rest. The expressive M leather steering wheel with its worked-in seams in the characteristic M colours gives you total control. This consistent quest for dynamism is reflected even in the smallest details – for example, when the **exclusive M interior trim finishers** excite you about getting on the road as soon as you enter the car.

□ Dynamic to the core: the bucket seat-style **M sport seats** optimise lateral support and highlight the sportiness of the interior, along with the M 'Carbon Fibre' interior trim finishers and the **M seat belts with stitching in M colours**.

□ The **M Carbon exterior package**, with its air curtain trim detailing, bumper trims, mirror caps and carbon rear spoiler, emphasises the dynamic look of the new BMW i4 M50. Even when switched off, the **M lights Shadow Line** draw attention to the innovative technology. The eye-catching **BMW Individual Frozen paintwork** and vehicle-specific **19" and 20" M light-alloy wheel** further strengthen this impression.

The M logo in the radiator grille and the blue BMW i ring mark the best of both worlds. The closed radiator grille with its premium patterning, an M rear spoiler and expressive aerodynamically optimised diffuser elements, in addition to numerous M-specific design details are the visual signs of a highly dynamic driving experience that has never before been seen.

■ The pure performance that lies within the new BMW i4 M50 is strikingly reflected in its powerful, athletic exterior design. Numerous M-specific elements, such as the **M aerodynamic package**, **M light-alloy wheels**, an **M logo on the radiator grille** and on the front side panels on the right and left, **M exterior mirror and design elements** in the **M signature colour Cerium Grey**, impressively showcase the symbiosis of strong power pack and agile athlete.

■ Standard equipment □ Optional equipment

The availability of some equipment, functions, and digital services depends on engine variants or additional optional equipment. The offer structure as well as market and

production availability may vary. For detailed information on availability, terms and costs, please contact your local BMW partner.



■ In **Sport Boost mode**, the two BMW M eDrive engines unleash up to 400 kW (544 hp) and seamlessly accelerate the new BMW i4 M50 **from 0 to 100 km/h in just 3.9 seconds¹** – values that impressively showcase the uncompromisingly athletic character of the new BMW i4 M50.

■ Two powerful BMW M eDrive engines create the power exactly where it is needed: directly on the axles. This electric all-wheel drive ensures maximum traction through actuator contiguous wheel slip limitation among other features, while the rear-focused design supports a sporty dynamic. This driving experience is accentuated by emotional M Sound, which innovatively sets the acoustic scene for the new BMW i4 M50.

COMPLETELY DYNAMIC. ELECTRICALLY INTERPRETED.

What do you feel when you drive the new BMW i4 M50? Pure ecstasy – the unique, characteristic M driving experience. Also as an electric model, a BMW M automobile unites dynamic top performance and adrenaline-charged driving behaviour with complete suitability for everyday driving.

■ Every M model is distinguished by the driving experience that is typical of the brand. The new BMW i4 M50 also excels in this respect. With adaptive M suspension, variable sport steering, the M sport brake and M-specific settings, it drives precisely and dynamically – and thanks to its extra low centre of gravity, it enjoys a particularly sporty position on the road.

■ Standard equipment □ Optional equipment

¹ Data represents preliminary figures that have not yet been officially confirmed.

The availability of some equipment, functions, and digital services depends on engine variants or additional optional equipment. The offer structure as well as market and production availability may vary. For detailed information on availability, terms and costs, please contact your local BMW partner.

BASE.



■ The black Sport leather steering wheel with four spokes features a Pearl Chrome decorative trim. A thick rim and contoured thumb rests provide an exceptionally pleasant, high-grip feel.

■ The Sport seats for driver and front passenger provide optimum lateral support with their raised side bolsters and manually adjustable thigh support. The fore-and-aft position, seat height and seat angle can be adjusted manually.

SELECTED BASE MODEL EXTERIOR EQUIPMENT FEATURES:

- LED headlights
- Taillights with LED technology
- Standard suspension
- 17" light alloy wheels V-spoke style 851

SELECTED BASE MODEL INTERIOR EQUIPMENT FEATURES:

- BMW Live Cockpit
- Sport leather steering wheel
- Automatic air conditioning
- Stereo speaker system
- Steptronic transmission
- Standard seat for driver and front passenger
- Cloth/Sensatec combination | Black
- High-gloss Black interior trim
- Floor mats in velour

The availability of some equipment, functions, and digital services depends on engine variants or additional optional equipment. The offer structure as well as market and production availability may vary. For detailed information on availability, terms and costs, please contact your local BMW partner.

■ Standard equipment □ Optional equipment

M SPORT PACKAGE.



■ The M Leather steering wheel including multifunction buttons, an M badge and an integrated driver-side airbag is featured in three-spoke design. With a reinforced steering wheel rim in leather 'Walknappa' Black with black stitching and contoured thumb rests, it provides a direct, athletic steering sensation.

■ The Sport seats for driver and front passenger provide optimum lateral support with their raised side bolsters and manually adjustable thigh support. The fore-and-aft position, seat height and seat angle can be adjusted manually.

M SPORT PACKAGE EXTERIOR EQUIPMENT:

- M Aerodynamics package with front apron, side sills and rear apron in vehicle colour with multi-piece insert in rear bumper in Dark Shadow metallic and Black high-gloss
- 18" M aerodynamic wheels 858 M Bicolour with mixed tyres; other wheels available
- M high-gloss Shadow Line, alternatively BMW Individual Exterior Line Aluminium satinised
- M designation on the sides
- Roof trim strip in vehicle colour
- Exclusive M Portimao Blue metallic paintwork or M Brooklyn Grey metallic; other paintwork available

M SPORT PACKAGE INTERIOR EQUIPMENT:

- M entry sills
- M driver footrest and M pedals
- Sport seats for the driver and front passenger in Alcantara/Sensatec combination with perforation and Blue contrast stitching; other upholsteries available
- Seat backrest width adjustment
- M leather steering wheel
- Vehicle key with exclusive M logo
- M anthracite headliner
- M interior trim finishers in Aluminium Tetragon; other trims available

The availability of some equipment, functions, and digital services depends on engine variants or additional optional equipment. The offer structure as well as market and production availability may vary. For detailed information on availability, terms and costs, please contact your local BMW partner.

■ Standard equipment □ Optional equipment

i4 M50.



■ 19" M light alloy wheels Double-spoke style 861 M Bicolour Jet Black uni with mixed tyres, gloss-lathed, wheel size front 8.5J x 19 with 245/40 R19 tyres, wheel size rear 9J x 19 with 255/40 R19 tyres.

□ The Sport seats for driver and front passenger provide optimum lateral support with their raised side bolsters and manually adjustable thigh support. The fore-and-aft position, seat height and seat angle can be adjusted manually.

M50 EXTERIOR EQUIPMENT RANGE:

- M rear spoiler
- M high-gloss Shadow Line
- 18" M aerodynamic wheels 858 M bicolour with mixed tyres
- SPORT BOOST
- Adaptive M suspension
- Variable sport steering
- M Sport brake

M50 INTERIOR EQUIPMENT RANGE:

- Alcantara/Sensatec combination | Black/contrast stitching in blue
- M Aluminium Rhombic Anthracite interior trim strips
- M Anthracite headliner
- BMW IconicSounds Electric
- M leather steering wheel

The availability of some equipment, functions, and digital services depends on engine variants or additional optional equipment. The offer structure as well as market and production availability may vary. For detailed information on availability, terms and costs, please contact your local BMW partner.

■ Standard equipment □ Optional equipment

EQUIPMENT HIGHLIGHTS.



□ In laser high-beam mode, the Adaptive BMW Laserlight illuminates a range of up to 550 m, nearly twice as far as that of conventional headlights. Better visibility in the dark significantly increases safety. Blue accents and the lettering "BMW Laser" in the headlight also underline the technological standards and the sporting character of the vehicle.



■ The one-piece Widescreen Display pairs ergonomically optimised intuitive operation with a display combination consisting of a 12.3" instrument display and a 14.9" control display. The latter can be conveniently controlled via a touchscreen. The free-floating look and the curved shape of the Widescreen Display provide an elegant impression.



□ Through the BMW Live Cockpit Professional emerges a frameless BMW Curved Display that combines a 12.3" instrument display and a 14.9" touch display. In addition, relevant information is projected onto the windshield via the BMW Head-Up Display¹.



□ Concierge Service, Remote Services, smartphone integration² incl. Apple CarPlay and Android Auto, In-Car Experiences, Connected Music or BMW Maps with Connected Navigation and Connected Parking? Get them all! With the Connected Package Professional, you can get all these services from BMW ConnectedDrive.

□ Driving Assistant Professional³ offers optimum comfort and safety during critical or monotonous traffic situations. Apart from the contents of the Driving Assistant, it also includes Steering and Lane Control Assistant with extended functions, Emergency Stop Assistant and Lane Keeping Assistant with active side collision protection.

□ Wouldn't it be incredible if your BMW was also your personal vehicle expert? Communicate with your vehicle using the BMW Intelligent Personal Assistant. Say natural commands to operate numerous vehicle functions. It can also explain topics about your vehicle and helps you to get to know your BMW even better.

□ With Remote 3D View, you can see your parked vehicle's surroundings from a distance on a smartphone. The function can be activated via the My BMW App. The 3D images can also be stored on the smartphone.

□ The Parking Assistant Plus⁴ makes parking and manoeuvring the vehicle easier. It features among others the Surround View system including Top View, Panorama View, Remote 3D View, as well as a lateral parking aid, the emergency braking function Active Park Distance Control, Parking Assistant with longitudinal and lateral guidance and Reversing Assistant.

□ The variable sport steering⁵ with Servotronic creates a direct and agile steering response and ensures that less physical effort is required to turn the wheel. It reacts to the angle of the steering wheel with varying steering ratios. This improves handling when driving more dynamically and reduces the effort needed to steer when parking and turning.

□ Why go without the features of your smartphone in your BMW when you can continue operating it as usual? With smartphone integration, your vehicle supports Apple CarPlay and Android Auto by means of a wireless connection between your smartphone and the vehicle. This allows you to conveniently use familiar functions and various apps in the vehicle.

■ Standard equipment □ Optional equipment

¹ The information in the BMW Head-Up Display is not fully visible when viewed through polarised sunglasses. Content shown will depend on the equipment options chosen. Further optional equipment is required to display specific items.

² Smartphone Integration is permanently available in the vehicle. It includes Apple CarPlay and Android Auto. Due to possible future technical developments (e.g. of mobile phones), the usability of the Apple CarPlay or Google Android Auto service cannot be guaranteed permanently. CarPlay is a trademark of Apple Inc. Android Auto is a trademark of Google LLC.

³ Function may be limited in darkness, fog or bright glare.

⁴ The driver is responsible for constantly monitoring the automated parking procedure in accordance with local road laws.

⁵ Standard for i4 M50.

The availability of some equipment, functions, and digital services depends on engine variants or additional optional equipment. The offer structure as well as market and production availability may vary. For detailed information on availability, terms and costs, please contact your local BMW partner.

EQUIPMENT HIGHLIGHTS. PERFORMANCE.



□ The M Technology package includes 19" M light alloy wheels Double-spoke style 861 M with sport tyres, which ensures maximum performance even in sporting use. In addition, the M Sport brake on the front axle is further reinforced thanks to larger brake discs. Exclusive 20" M light alloy wheels Double-spoke style 868 M with sport tyres are optionally available.



□ The Sport seats for driver and front passenger provide optimum lateral support with their raised side bolsters and manually adjustable thigh support. The fore-and-aft position, seat height and seat angle can be adjusted manually.

■ In the **SPORT BOOST** driving mode, the BMW M eDrive engines provide added performance of up to 50 kW (68 hp). In this case the drive reacts more sensitively to the acceleration commands. The clearly noticeable boost function provides superior engine power and thus creates a unique, particularly sporty driving experience.

■ Standard equipment □ Optional equipment

The availability of some equipment, functions, and digital services depends on engine variants or additional optional equipment. The offer structure as well as market and

production availability may vary. For detailed information on availability, terms and costs, please contact your local BMW partner.

EXTERIOR COLOUR WORLD.

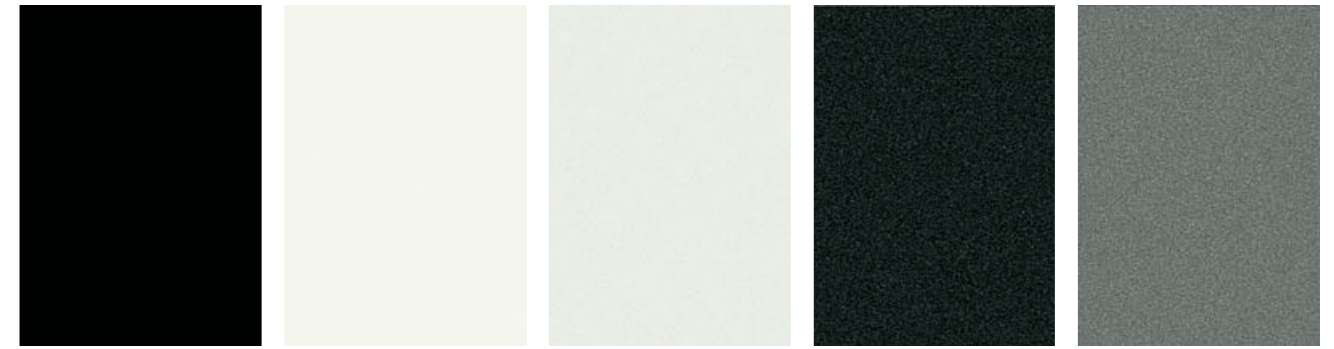

■ Non-metallic 668 Black² □ Non-metallic 300 Alpine White¹ □ Metallic A96 Mineral White □ Metallic 475 Black Sapphire □ Metallic C4W Skyscraper Grey

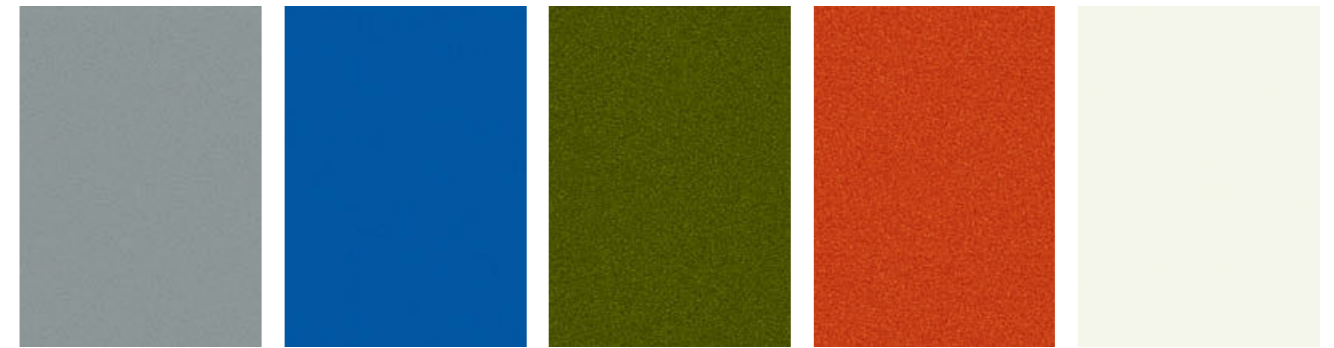

□ Metallic C4P M Brooklyn Grey³ □ Metallic C31 M Portimao Blue³ □ Metallic C4E Sanremo Green □ Metallic C1X Sunset Orange □ BMW Individual 490 special paintwork (e.g. Brilliant White metallic)⁴

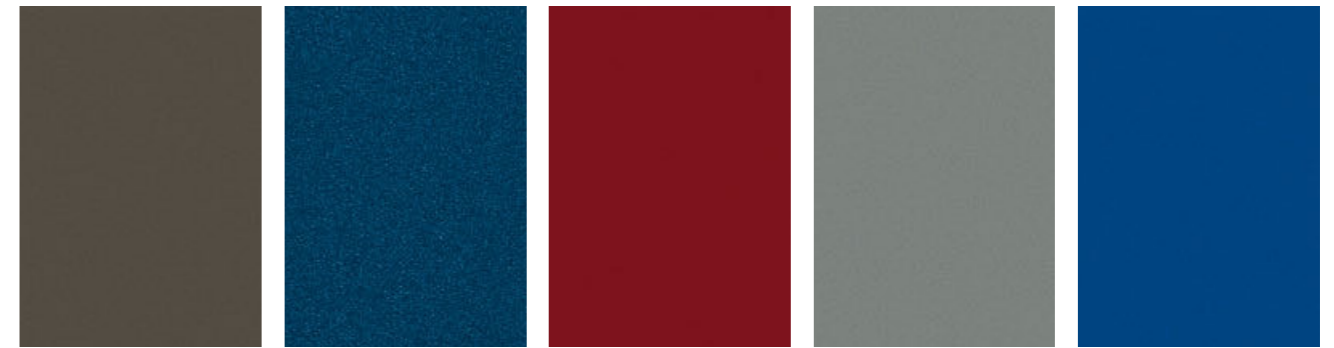

□ BMW Individual C36 Dravite Grey metallic □ BMW Individual C3Z Tanzanite Blue metallic □ BMW Individual C57 Aventurine Red metallic □ BMW Individual special paintwork Frozen Pure Grey metallic⁴ □ BMW Individual special paintwork Frozen Portimao Blue metallic

■ Standard equipment □ Optional equipment

[Colour samples] These colour samples are intended as an initial guide to the colours and materials available for your BMW. However, experience has shown that printed versions of paint, upholstery and interior trim colours cannot in all cases faithfully reproduce the appearance of the original colour. Please discuss your preferred colour choices with your BMW partner or in your dealership. There you can also see original samples and be assisted with special requests.

¹ Available as standard for the M Sport package and i4 M50.

² Not available for the M Sport package and i4 M50.

³ Only available for M Sport package and i4 M50.

⁴ Expected to be available from 03/22.

The availability of some equipment, functions, and digital services depends on engine variants or additional optional equipment. The offer structure as well as market and production availability may vary. For detailed information on availability, terms and costs, please contact your local BMW partner.

INTERIOR COLOURS.

UPHOLSTERY COLOURS



■ Cloth/Sensatec combination KFSW Black



□ Alcantara/Sensatec combination KGNL Black with perforation, accent Blue^{1,2}



□ Sensatec perforated KHFR Canberra Beige with extended contents

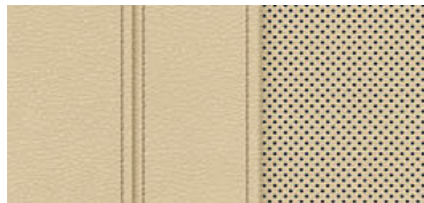

□ Sensatec perforated KHFS Canberra Beige with extended contents



□ Sensatec perforated KHG7 Tacora Red



□ Sensatec perforated KHKC Cognac with extended contents



□ Sensatec KHSW perforated Black



□ Leather 'Vernasca' MAG6 Tacora Red with decorative stitching



□ Leather 'Vernasca' MAH7 Black decor stitching

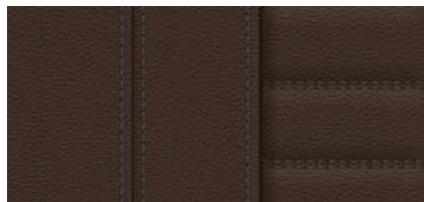

□ Leather 'Vernasca' MAMU Mocha decor stitching

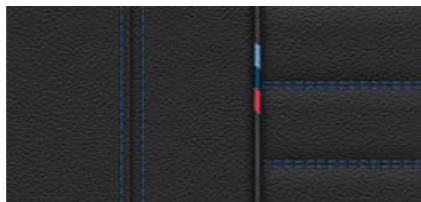

□ Leather 'Vernasca' MANL Black, Blue contrast stitching³

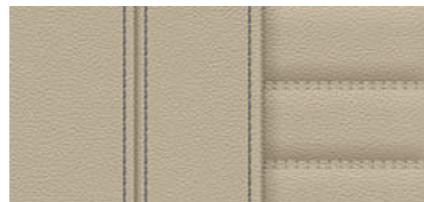

□ Leather 'Vernasca' MAOI Oyster decor stitching

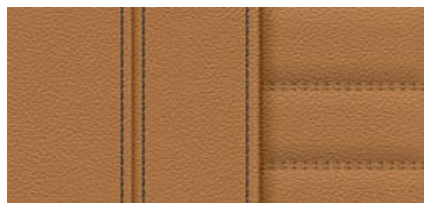

□ Leather 'Vernasca' MAPQ Cognac decor stitching

■ Standard equipment □ Optional equipment

¹ Available as standard for the M Sport package.

² Standard for i4 M50.

³ Only available for M Sport package and i4 M50.

The availability of some equipment, functions, and digital services depends on engine variants or additional optional equipment. The offer structure as well as market and production availability may vary. For detailed information on availability, terms and costs, please contact your local BMW partner.

Please note that even normal long- or short-term use can lead to unrecoverable upholstery damage. This can be caused in particular by non-colourfast clothing. Please note that the interior colour depends on the selected upholstery colour.

INTERIOR COLOURS.

BMW INDIVIDUAL



□ BMW Individual extended leather trim 'Merino' VAEW Ivory White¹

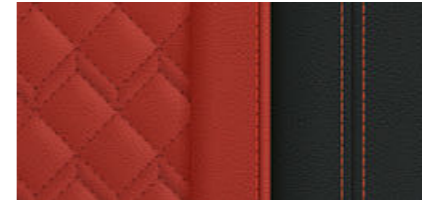

□ BMW Individual extended leather trim 'Merino' VAHZ Fiona Red/Black¹



□ BMW Individual extended leather trim 'Merino' VATQ Tartufo¹

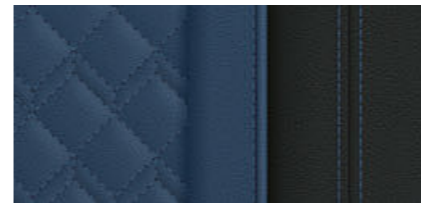

□ BMW Individual extended leather trim 'Merino' ZAFV Fjord Blue/Black¹

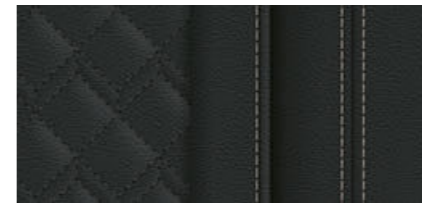

□ BMW Individual extended leather trim 'Merino' ZASW Black¹

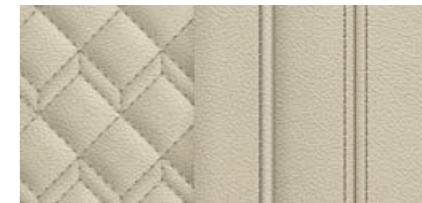

□ BMW Individual full leather trim 'Merino' VBEW Ivory White¹



□ BMW Individual full leather trim 'Merino' VBHZ Fiona Red/Black¹

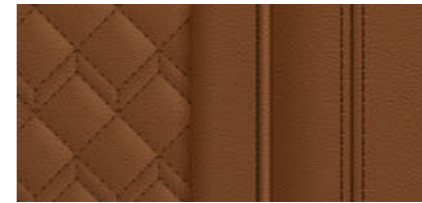

□ BMW Individual full leather trim 'Merino' VBTQ Tartufo¹



□ BMW Individual full leather trim 'Merino' ZBFV Fjord Blue/Black¹

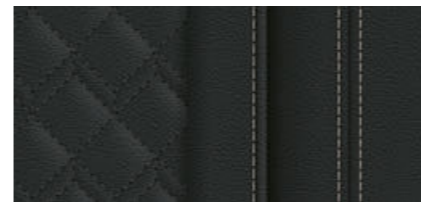

□ BMW Individual full leather trim 'Merino' ZBSW Black¹

■ Standard equipment □ Optional equipment

¹ Expected to be available from 03/22.

The availability of some equipment, functions, and digital services depends on engine variants or additional optional equipment. The offer structure as well as market and production availability may vary. For detailed information on availability, terms and costs, please contact your local BMW partner.

Please note that even normal long- or short-term use can lead to unrecoverable upholstery damage. This can be caused in particular by non-colourfast clothing. Please note that the interior colour depends on the selected upholstery colour.

INTERIOR COLOURS.

INTERIOR TRIM FINISHERS

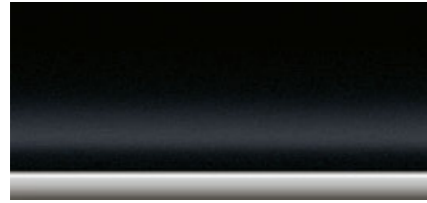

■ Interior trim finishers black high-gloss¹



□ Fine-wood interior trim oak grain open-pored



□ Fine-wood interior trim Ash grey-brown high-gloss



□ Interior trim finishers Aluminium Rhombicle Anthracite³

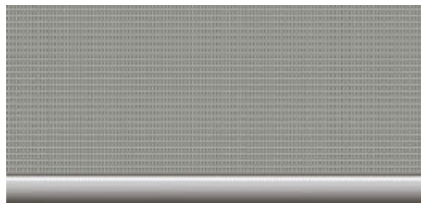

□ Interior trim finishers Aluminium 'Mesheffect'



□ M interior trim finishers 'Carbon Fibre'²

BMW INDIVIDUAL



□ BMW Individual interior trim finishers piano finish Black



□ BMW Individual interior trim finishers Aluminium fabric high-gloss

■ Standard equipment □ Optional equipment

¹Not available for i4 M50.

²Only available for M Sport package and i4 M50.

³Standard for i4 M50.

The availability of some equipment, functions, and digital services depends on engine variants or additional optional equipment. The offer structure as well as market and production availability may vary. For detailed information on availability, terms and costs, please contact your local BMW partner.

Please note that even normal long- or short-term use can lead to unrecoverable upholstery damage. This can be caused in particular by non-colourfast clothing. Please note that the interior colour depends on the selected upholstery colour.

WHEELS AND TYRES.



■ 17" light alloy wheels V-spoke style 851 Silver Grey uni, wheel size 7.5J x 17 with 225/55 R17 tyres.¹



□ 17" aerodynamic wheels 852 Bicolour Black Grey, gloss-lathed, wheel size 7.5J x 17 with 225/55 R17 tyres.¹

□ 18" light alloy wheels Double-spoke style 853 Bicolour Dark Grey with mixed tyres, gloss-lathed, wheel size front 8.5J x 18 with 245/45 R18 tyres, wheel size rear 9J x 18 with 255/45 R18 tyres.¹

□ 18" aerodynamic wheels 854 in Multicolour Dark Grey uni with mixed tyres, wheel size front 8.5J x 18 with 245/45 R18 tyres, wheel size rear 9J x 18 with 255/45 R18 tyres.¹



□ 18" M aerodynamic wheels 858 M Bicolour Black Grey with mixed tyres, gloss-lathed, wheel size front 8.5J x 18 with 245/45 R18 tyres, wheel size rear 9J x 18 with 255/45 R18 tyres.^{2,3}



□ 19" aerodynamic wheels 855 Bicolour Dark Grey with mixed tyres, gloss-lathed, wheel size front 8.5J x 19 with 245/40 R19 tyres, wheel size rear 9J x 19 with 255/40 R19 tyres.¹



□ 20" BMW Individual aerodynamic wheels 862 I Bicolour Black Grey with mixed tyres, gloss-lathed, wheel size front 8.5J x 20 with 245/35 R20 tyres, wheel size rear 9J x 20 with 255/35 R20 tyres.

□ 19" M light alloy wheels Y-spoke style 859 M Bicolour Jet Black uni with mixed tyres, gloss-lathed, wheel size front 8.5J x 19 with 245/40 R19 tyres, wheel size rear 9J x 19 with 255/40 R19 tyres.²

□ 19" M aerodynamic wheels 860 M Bicolour Black Grey with mixed tyres, gloss-lathed, wheel size front 8.5J x 19 with 245/40 R19 tyres, wheel size rear 9J x 19 with 255/40 R19 tyres.²



□ 19" M light alloy wheels Double-spoke style 861 M Bicolour Jet Black uni with mixed tyres, gloss-lathed, wheel size front 8.5J x 19 with 245/40 R19 tyres, wheel size rear 9J x 19 with 255/40 R19 tyres.⁴



□ 20" M light alloy wheels Double-spoke style 868 M Bicolour Jet Black uni with mixed tyres and sport tyres, gloss-milled, wheel size front 8.5J x 20 with 255/35 R20 tyres, wheel size rear 10J x 20 with 285/30 R20 tyres.⁴

■ Standard equipment □ Optional equipment

¹Not available for i4 M50.

²Only available for M Sport package and i4 M50.

³Standard for i4 M50.

⁴Only available for i4 M50.

The availability of some equipment, functions, and digital services depends on engine variants or additional optional equipment. The offer structure as well as market and production availability may vary. For detailed information on availability, terms and costs, please contact your local BMW partner.

TECHNICAL VALUES.

BMW i4		i4 eDrive40	i4 M50
Weight and volume			
Unladen weight EC ¹	kg	2125	2290
Maximum permissible weight	kg	2605	2735
Luggage capacity	l	470-1290	470-1290
Output and torque			
Maximum output	kW (hp)	250 (340)	400 (544)
Maximum torque	Nm	430	795
Lithium-ion high-voltage battery			
Net battery capacity	kWh	80.7	80.7
Charging time (AC 0-100 %) ²	h	8.5	8.5
Charging time (DC 10-80 %) ²	min	31	31
Power transmission			
Type of drive	-	Rear-wheel	All-wheel
Performance			
Top speed	km/h	190 ⁷	225 ⁷
Acceleration 0-100 km/h	s	5.7 ⁷	3.9 ⁷
Consumption and range			
WLTP ^{3,5}	-		
• Power consumption, combined ⁴	kWh/100 km	20-16 ⁷	24-19 ⁷
• Electric range ⁶	km	up to 590 ⁷	up to 510 ⁷
Wheels/tyres			
Standard wheels	-	Front: 225/55 R17 101 Y.XL Rear: 225/55 R17 101 Y.XL	Front: 245/45 R18 100 Y.XL Rear: 255/45 R18 103 Y.XL

TECHNICAL VALUES.

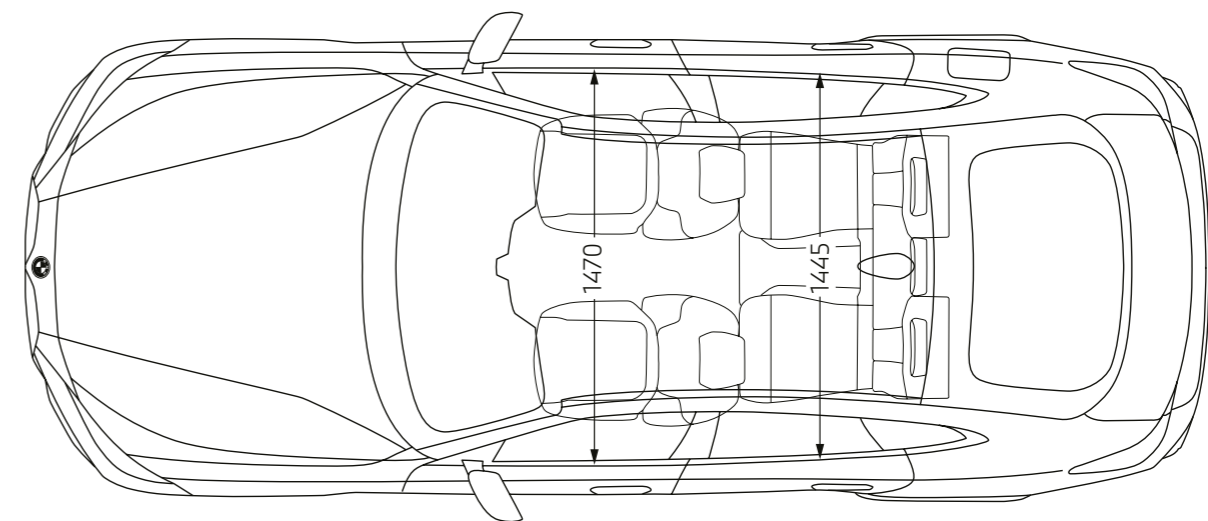
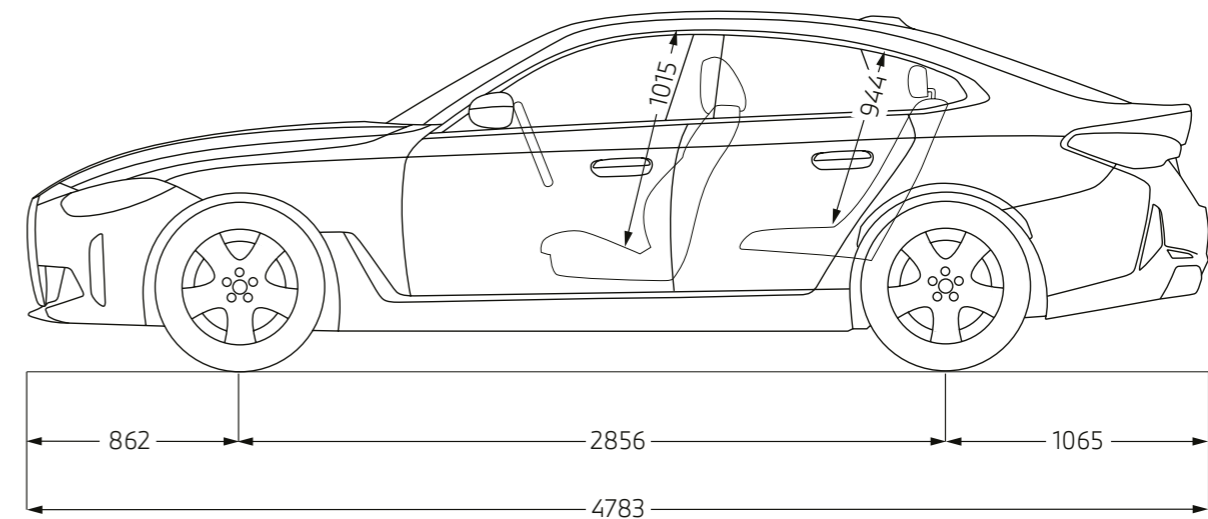
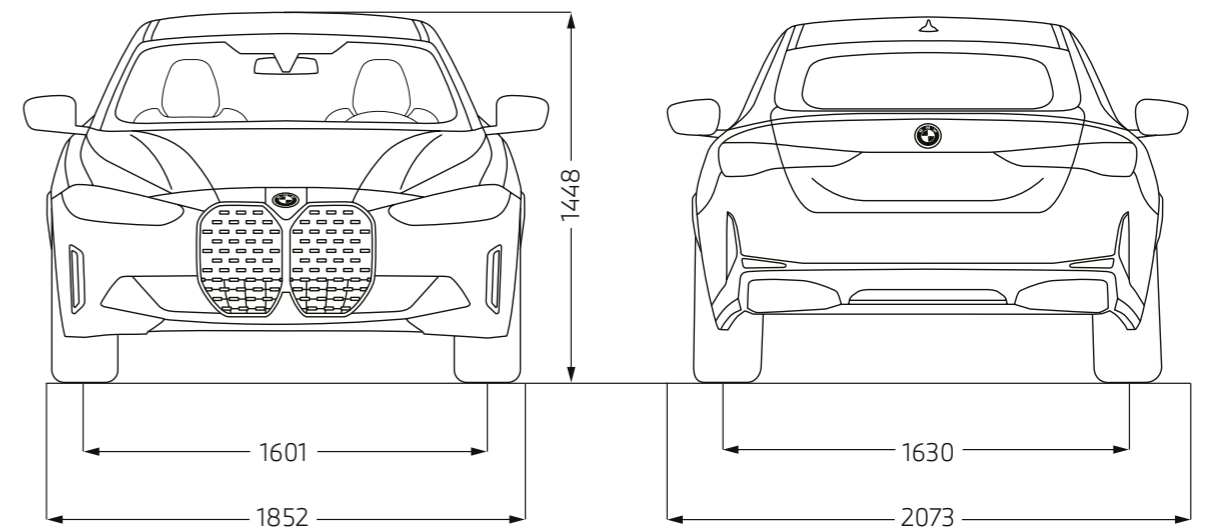

¹ The figures quoted are based on a driver weight of 75 kg. Unladen weight applies to vehicles with standard equipment. Optional equipment may affect the weight of the vehicle, the payload and the top speed if the equipment has an impact on the vehicle's aerodynamics.

² Dependent on the local electricity infrastructure. AC charging time refers to a charging power of 11 kW; DC charging time refers to a charging power of 200 kW.

³ Official data for power consumption and electric range was determined in accordance with the measuring procedures as defined by European Regulation (EU) 715/2007 in the applicable version and comply with same. In the event of ranges, data determined as per WLTP takes into account any optional equipment (available on the German market in this case). For vehicles that have been newly type approved since 1 January 2021, only the official data according to WLTP exist. For more information about NEDC and WLTP measuring procedures visit www.bmw.com/wltp

⁴ The combined consumption range depends on the selected wheel and tyre sizes.

⁵ As of 1 September 2017, the type approval for certain new vehicles is granted according to the Worldwide harmonised Light vehicles Test Procedure (WLTP), a new, more realistic test procedure to measure the fuel consumption and carbon dioxide emissions. As of 1 September 2018, the WLTP replaced the New European Driving Cycle (NEDC), the previous test procedure. As a result of the more realistic test conditions, the fuel consumption and CO₂ emission values measured as per WLTP are, in many cases, higher than the values measured according to the NEDC.

⁶ Range depends on various factors, in particular: individual driving style, route characteristics, outside temperature, heating/air conditioning, pre-conditioning.

⁷ Provisional figures; any missing figures were unavailable at the time of publication.

The dimensions in the technical drawing are in millimetres and may vary depending on the model and equipment.

Of course, each vehicle is designed for economical recycling after its long-running life. You can find more information regarding your end-of-life vehicle on our website www.bmw.de/recycling

© BMW AG, Munich, Germany. Not to be reproduced wholly or in part without prior written permission of BMW AG, Munich.